

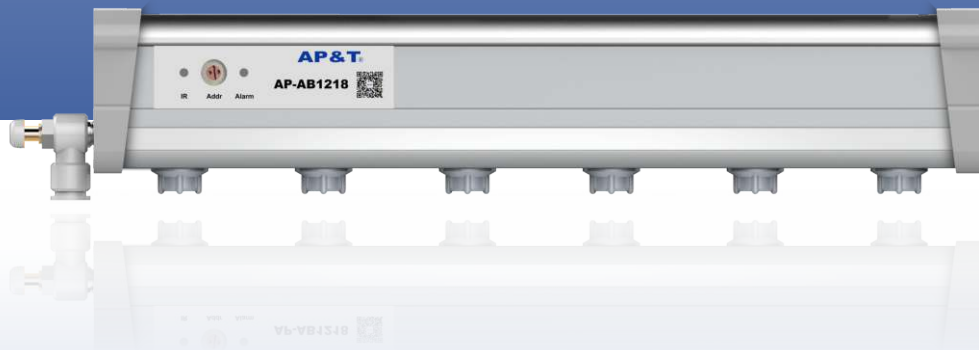

Shanghai Anping Static Technology Co.,Ltd

# Air-source Electroshock-proof Pulse AC Ion Bar

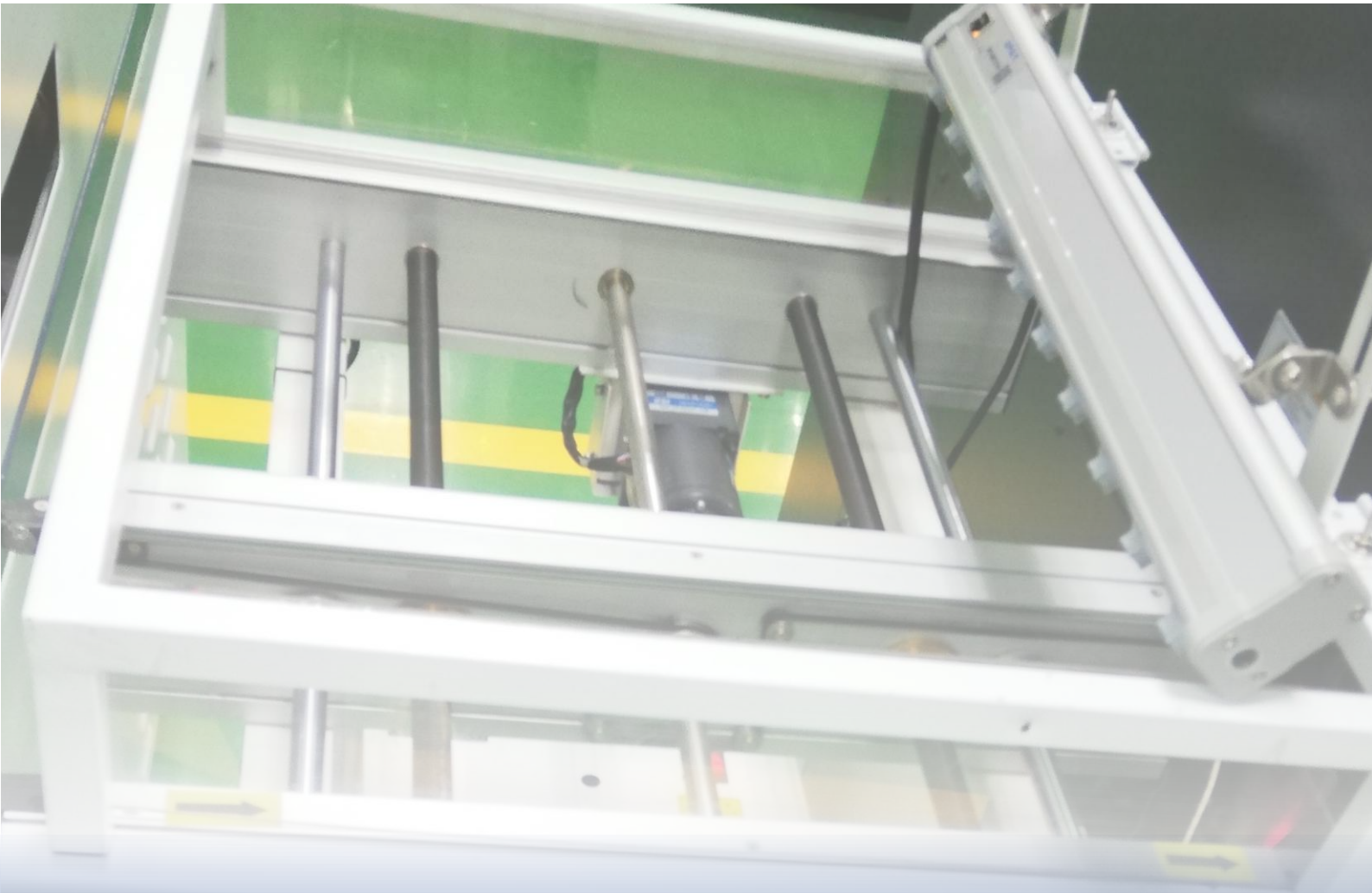



Suitable for electronics, optoelectronics,  
semiconductor and other industries

Effectively solve the problems  
caused by static electricity



Static removal

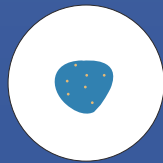

Prevent adhesion of objects

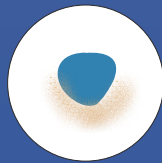

Prevent material splash

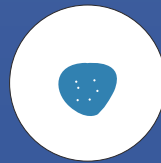

Prevent static electricity



Prevent blockage of feeder

# Intelligent Remote Control

Ion balance/ion output frequency adjustable

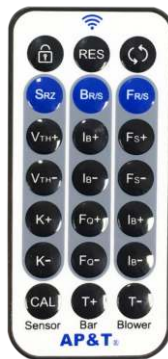

## Remote control button function

Unlock ( Unlock before adjusting operating )

- 1、 30s delay if any key is pressed after unlocking
- 2、 Exit and re-locked if no key is pressed after unlocking

User manual:

$B_{RS}$ : Run and pause

IB+ / IB-: Balance adjustment ( 5%-95%, unit is 0.1% )

$F_0+$  /  $F_0-$ : Frequency adjustment ( unit is 1HZ )

T+ / T-: Cleaning time adjustment (unit is 1D=24H)

## Ion balance adjustable

Press "IB -" when the positive voltage on flat panel charge detector or object surface is high, press "IB +" when the negative voltage on flat panel charge detector or object surface is high until the ion balance reaches the ideal status. Balance voltage can be adjusted by adjusting the output ratio of positive and negative ions, which can increase the static electricity removing speed.

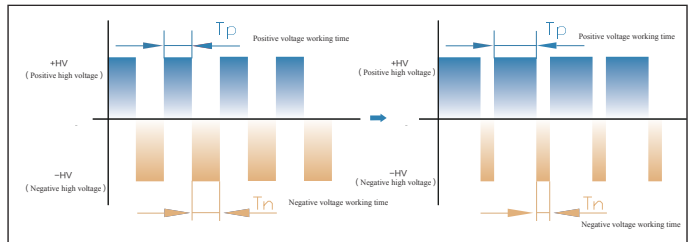

## Output frequency of positive & negative ion adjustable

The output frequency of positive and negative ion is adjustable, which is suitable for different discharge distance. And its static elimination ability can be exerted no matter in short or long distance. Ex-work setting is 30Hz. Frequency can be adjusted with remote control and result is visible through the plate tester.

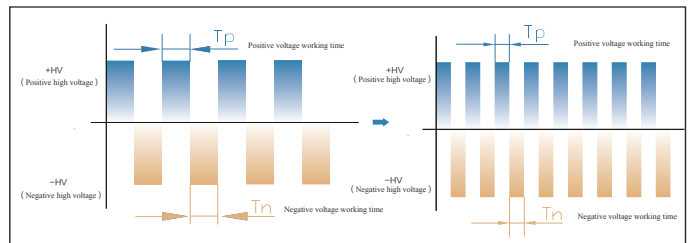

# Pulse AC

Discharge effect is better compare to power frequency AC ion bar

## Pulse AC VS traditional AC

Pulse AC method generate ions with two polarity by applying "+" and "-" high voltage alternately on each electrode needles.

Compared with power frequency AC method, the utilization rate of ion generation is higher. And its static elimination ability can be exerted no matter in short or long distance. In addition, the discharge frequency can be adjusted, which can extend the discharge distance. The output ratio of positive and negative ions can be adjusted, which is convenient for intelligent control.

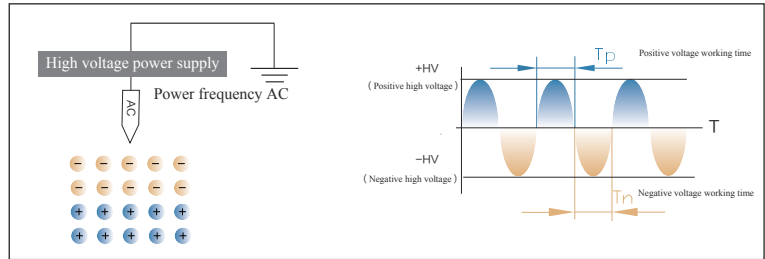
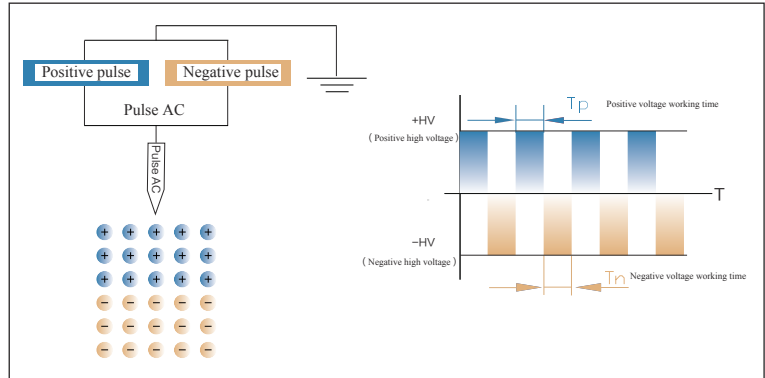

## 3 situations of static electricity on the surface of the object



Decrease  $T_p$  so that the positive voltage acting capacity becomes smaller and the acting time becomes shorter. Less positive ions and more negative ions output to neutralize the excess positive charge on the surface of the object.



Increase  $T_p$  so that the positive voltage acting capacity becomes greater and the acting time becomes longer. More positive ions and less negative ions output to neutralize the excess negative charge on the surface of the object.



Adjust the duty ratio  $[T_p/(T_p+T_n)]$  to an appropriate ratio and send out the same amount of positive and negative ions to neutralize the static electricity on the surface of the object.

# High Efficiency Static Removal

Keep a clean production environment and stay away from static electricity

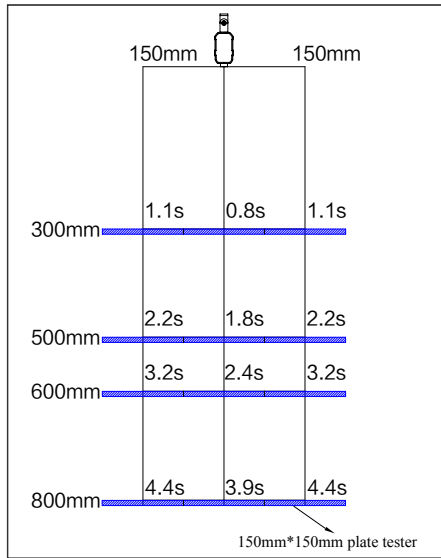

Test Condition: Ion bar length: 360mm  
Airflow pressure: 0.2Mpa  
Working frequency: 30Hz

Test standard: ANSI/ESD.STM3.1, SJ/T 11446—2013

Test instrument: Trek charge plate tester

Test voltage: ±1000V → ±100V attenuation

Test environment: humidity 50±5%; temperature 23±3℃

The test data diagram is as follows (Test distance: 300mm, Ion bar length: 360mm, Airflow pressure: 0.2Mpa, Working frequency: 30Hz) :

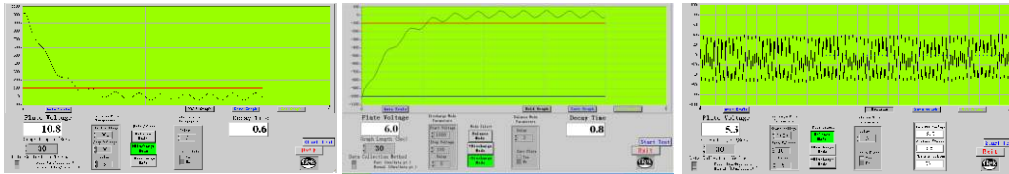

## Test data under other conditions are as follows

Ion bar

Horizontal test distance X

Vertical test distance Z

Plate tester

Test bearing chart

Ion bar length: 360mm; Working frequency: 30Hz;						
Test distance (mm)		Airflow pressure (MPa)	Duty ratio (%)	Discharge performance		
Vertical	Horizontal			Positive discharge time (S)	Negative discharge time (S)	Balance voltage (V)
300	-150	0.2	50	0.9	1.1	11.0
			50	0.6	0.8	8.0
			50	0.7	1.0	-4
	0	0.4	51	0.6	0.6	4.0
			51	0.5	0.6	14
			51	0.5	0.6	5
	150	0.6	51	0.6	0.6	17
			51	0.4	0.4	-2
			51	0.4	0.4	6
500	-150	0.2	50	1.7	2.2	10.0
			50	1.4	1.8	8.0
			50	1.5	2.1	-6
	0	0.4	51	1.4	1.4	13.0
			51	1.0	1.3	12
			51	1.1	1.4	-6
	150	0.6	51	1.1	1.3	-17
			51	1.0	1.2	15
			51	1.0	1.2	9
600	-150	0.2	50	2.3	3.2	6.0
			50	2.0	2.4	7.0
			50	2.0	3.2	3
	0	0.4	51	1.6	2.1	13.0
			51	1.4	1.9	-10
			51	1.5	2.0	7
	150	0.6	51	1.4	2.0	-13
			51	1.3	1.6	-4
			51	1.3	1.7	-4
800	-150	0.2	50	3.9	4.4	7.0
			50	2.8	3.9	3.0
			50	3.4	4.3	4
	0	0.4	51	2.7	3.4	7.0
			51	1.9	2.8	15
			51	2.2	3.0	6
	150	0.6	51	2.0	2.6	-13
			51	1.6	2.4	4
			51	1.7	2.5	8

Note: 1\*—Real-time pressure value during airflow  
The balance voltage performance of the ion bar varies depending on bar length, airflow pressure, working frequency, and installation distance. The duty ratio should be adjusted according to the specific use environmental conditions to make the balance performance of the ion bar reach the best state.

# Features

Safe / Easy to use / Durable

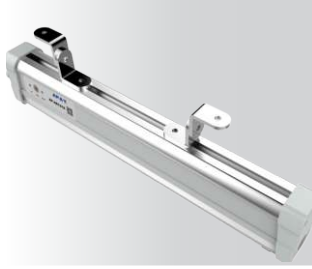

No.1

## Easy installation

Fit for various installation environments with stainless steel mounting bracket.

No.2

## Intake throttle valve

The specification is  $\Phi 8$ -G1/8 grey.

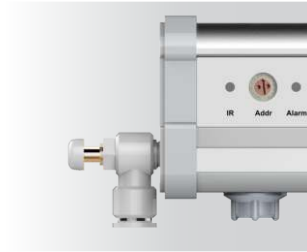

No.3

## High voltage abnormal alarm

Green light: normal working  
Red light: high voltage abnormal.



No.4

## External PLC

The external PLC can carry out high-voltage alarm, power-on indication, and cleaning indication monitoring output.

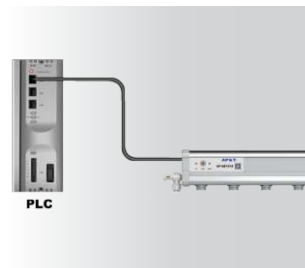

No.5

## CE certification

It can effectively avoid external electromagnetic interference affecting the normal operation of the ion bar which is a high-security and high-reliability static eliminator.

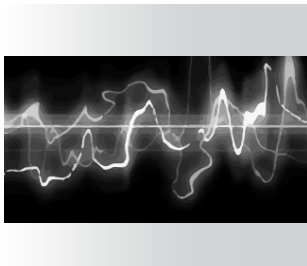

# Product Use

Product details/ product size / product specification

## Product details

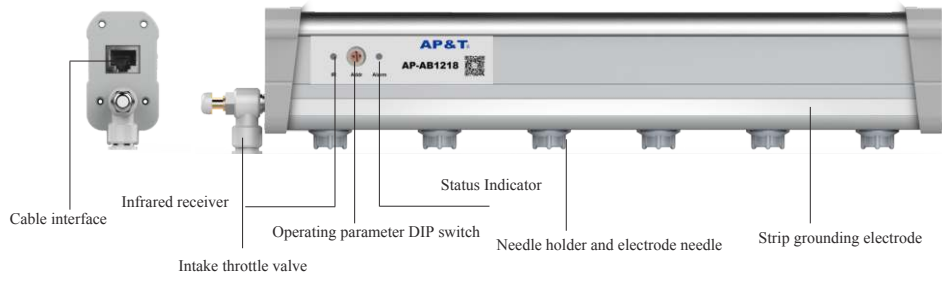

### DIP switch:

- 0: Pause / Modify address
- 1: 0.1HZ
- 2: 1HZ
- 3: 3HZ
- 4: 5HZ
- 5: 10HZ
- 6: 20HZ
- 7: 30HZ
- 8: 50HZ
- 9: 70HZ
- A: 80HZ
- B: 100HZ
- C: 50HZ ( addition and subtraction per 1 frequency )
- D: 100HZ ( addition and subtraction per 1 frequency )
- E: Positive (P:95%、N:5%-100HZ)
- F: Negative (N:95%、P:5%-100HZ)

### Indicator function:

- Blue light: infrared, pause, cleaning indication
- Green light: run
- Red light: alarm indication

### NPN function:

- 7: High voltage indication
- 8: Power-on indication, cleaning indication



## Product size

Unit: mm

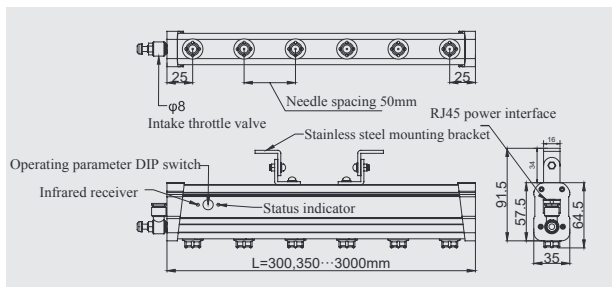

Ion bar dimensions

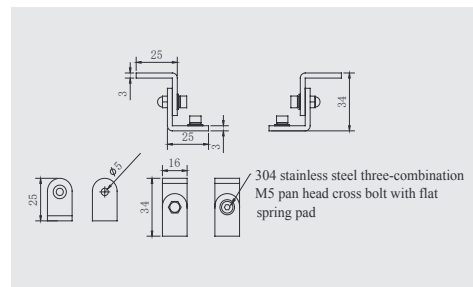

Mounting bracket dimensions

## Product specification

Model	AP-AB1218
Input voltage	DC 24V
Input current	< 600mA
Power	10W
Working voltage	DC±5KV
Ion emission	Pulse AC
Emitter electrode	Tungsten alloy
Discharge structure	Resistance coupling
Output frequency	0.1,1,3,5,10,20,30,50,70,80,100Hz; ( ex-work setting: 50Hz)
Duty ratio	10%—90%
Discharge range	L*W*H: {300-3000mm }*300*1000mm
Installation distance	100 → 1000mm
Ion balance	≤ ±30V  ( AVG )
Discharge time	≤ 2S
Alarm indication	High voltage alarm indicator(Green light: Normal working, Red light : Abnormal high voltage )
Communication function	RS485
Signal output	Collector open circuit 50V/100mA
Air pressure	≤ 0.6MPa
Intake throttle valve connector	Φ8-G1/8 Grey
Working temperature	0℃ -50℃
Working humidity	< 70%
Dimensions	L*W*H: {300-3000mm}*35*64.5mm
Bar material	Flame retardant PVC、AL、SUS
Packaging accessories	180°rotatable mounting bracket, M5-12*12*4 square nut
Warranty	1Year
Certification	CE



# Products Use

Step of use/Installation position/Packing accessories

## Step of use

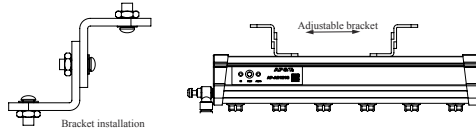

1

Take out ion bar, power adapter, power cable, stainless steel mounting bracket and other accessories from the packing box and install the stainless steel mounting bracket on the mounting slot of the ion bar base.

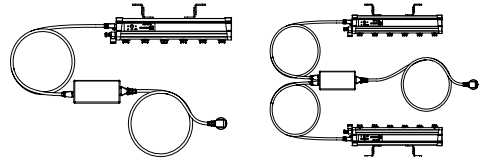

one adapter for one bar

one adapter for two bars

2

Insert one end of the power cable into the RJ45 connector of the power adapter and the other end into the RJ45 connector of the power adapter on the bar body. One adapter can connect up to two ion bars.

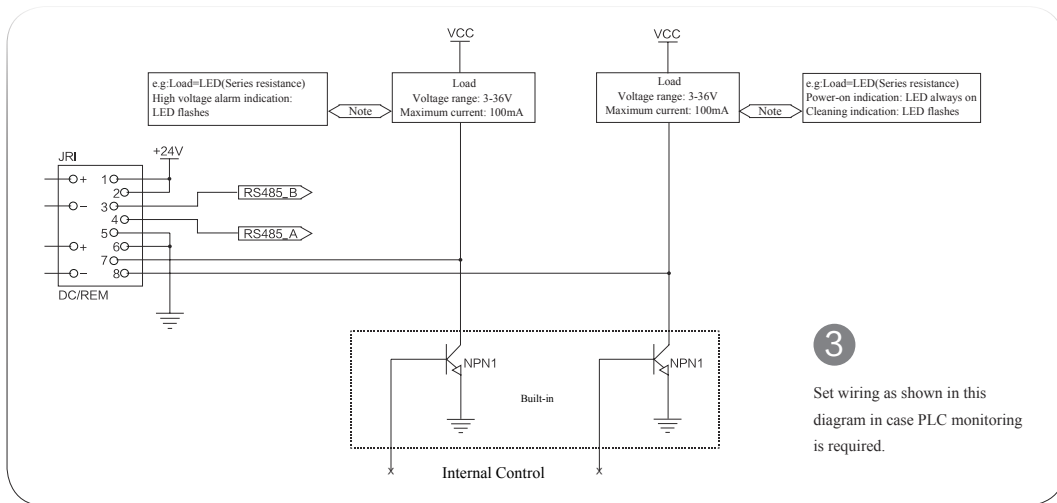

3

Set wiring as shown in this diagram in case PLC monitoring is required.

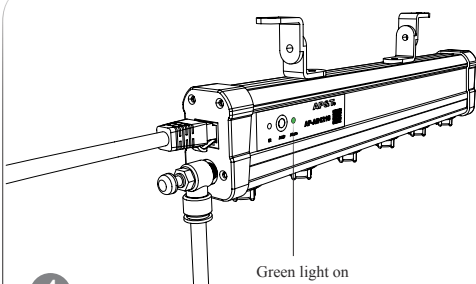

4

Connect the air source connector on the bar body to the air generating equipment and turn on the air source switch. The network port power indicator light on and the panel indicator light green shows ion bar working normally.

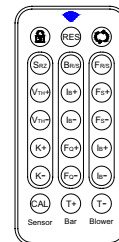

5

Use the remote control to adjust the voltage output parameters under the suitable airflow pressure. Press "IB -" when the positive voltage on flat panel charge detector or object surface is high, press "IB +" when the negative voltage on flat panel charge detector or object surface is high until the ion balance reaches the ideal status.

## Installation position

1. Choose the best static elimination position and install the bar body and the matching power adapter firmly after the static detection of the on-site working environment. The installation angle should be perpendicular to the surface of the charged body and the installation distance can be referred to the following table. (Ex-work setting is 50Hz. Please refer to the instructions of operating parameters DIP switch on the panel or adjust the DIP switch to C or D position, then use the remote control to adjust if you need to adjust the output frequency. Configure a flat panel tester if you want to see the adjustment results)

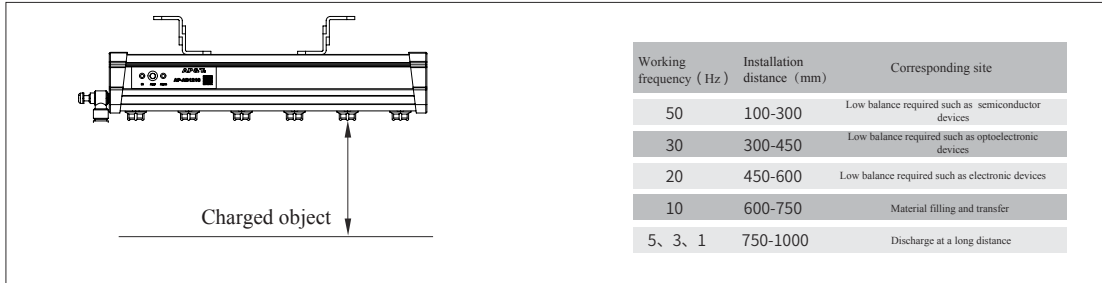

2. Ion bar strip grounding electrode is not allowed to be covered by other objects.

3. Two ion bars should be installed side by side with an interval of more than 300mm and should be staggered by more than 300mm if installed face-to-face.

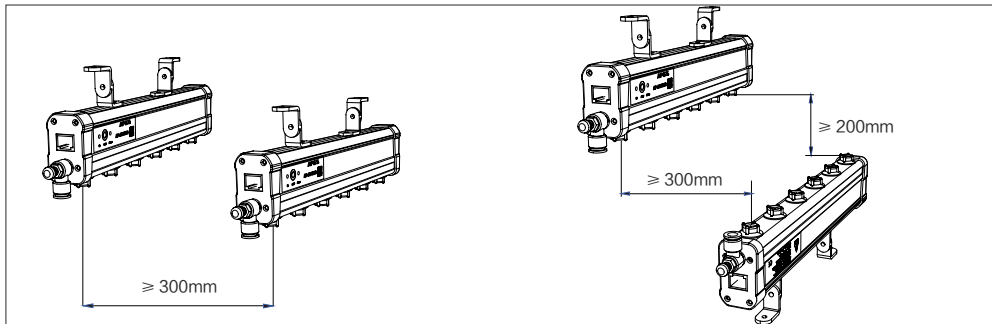



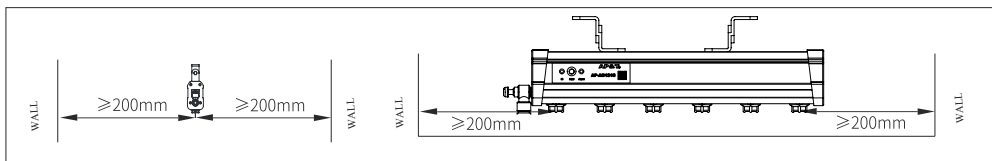



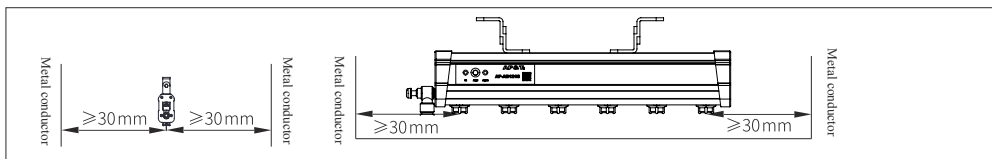





4. More than 200mm away from obstacles such as walls.



5. Ion bar should be at least 30mm away from the metal conductor and metal grounding body around the electrode and the bar body must be reliably connected to the ground wire.



## Packing accessories

Part name	Picture	Part No.	Specification	
Power adapter		OSP000601	GRT-240200: DC24V 2A, Dual network port output, dimension:123*61*40.5mm (L*W*H)	1
National standard power cord		8YXG25110	Standard 1.8m, optional 3m/5m	1
Double-end crystal head black shield ethernet cable		8WXI00004	Standard 2.5m, optional 5m/10m	1
Single-end crystal head black shield ethernet cable		8WXI00002	FUTP CAT.5E 26AWG 4Pair Jacket PVC OD:5.6±0.2mm bag packed	optional
L-shaped stainless steel mounting bracket		AP8038005	Height 25mm /Width 16mm/Thickness 3mm/Aperture 5mm (measured 4.8mm)	4
Square nut		AP8933000	M5*12*12*4	2
304 stainless steel spring washer		AP8943000	M5	6
304 stainless steel flat gasket		AP8946004	M5	6
304 stainless steel pan head Phillips screw		AP8900001	M5*12	6
Hex nuts		1LML05000	M5	4
Intake throttle valve		3JTQF0801	Standard 8mm, optional 6mm	1
Needle holder		AP6604000	—	—
Remote control		ZX2253000	Infrared remote control , neutral panel (L*W*H : 85.76*39.76*6.66)	1

### ⚠ Safety warning

1. Please read the instruction manual carefully before installing and using this equipment.
2. The whole set of equipment must be reliably grounded during use, otherwise it is easy to cause abnormality or even damage to the ion bar.
3. Do not use this equipment in environment where humidity is > 70%.
4. It is strictly forbidden to use this equipment in flammable and explosive environments.
5. Unauthorized disassembly of the product is strictly prohibited, internal maintenance and repair must be performed by professionals.
6. The product is strictly prohibited to touch liquid during use, otherwise an abnormality may occur and cause electric shock or fire.
7. Power must be turned off during inspecting or replacing the product, otherwise it may cause electric shock or fire.
8. The product is ventilated with dry and clean air or nitrogen which will work abnormally or be damaged if the gas source contains water or grease.
9. The product is specially designed to eliminate static electricity. It is strictly forbidden to use it for other purposes. Any abnormal use may cause machine failure, electric shock, fire and other accidents.
10. Its strictly forbidden to touch the electrode needles when power is on, otherwise it is easy to cause malfunctions and electric shock accidents.
11. The electrode needle is a sharp metal object, please use it with care.
12. Please check the specifications of the power supply before powering on the product. Any power supply that does not meet the specifications will cause damage to the product.
13. Please check the product power cord/communication cord regularly and replace it immediately if it is damaged. Otherwise it is easy to cause problems such as electric leakage, poor communication, and abnormal operation.

## ▲ Trouble shooting

NO	Faults	Reasons	Solutions
1	The power port indicator does not light up	Poor contact of the power cable	Check whether the power cable is in good condition and securely connected
		Power supply mismatch	Confirm the power supply specification ( INPUT: 100—240VAC 50/60Hz; OUTPUT: 24VDC 2000mA )
2	The electrostatic removal performance decreased obviously	Discharge needle is polluted and damaged	Clean or replace the discharge needle
		Whether the discharge seat is tightened	Confirm the discharge seat is tightened
		Ion bar positioning is incorrect	Confirm the best installation location
3	The electrostatic removal performance decreased	There are conductors or other ion bar around	Remove (moving) conductors or other ion bar
4	High voltage alarm ( Panel indicator red light on )	Electromagnetic interference	Turn off the power switch / unplug the power cable, restart the ion bar
		Abnormal discharge	Confirm the installation location and stay away from surrounding conductors
		No power supply for high voltage module	Return to factory for maintenance
		High voltage module is damaged	Return to factory for maintenance
5	Unable to discharge	High voltage module is damaged	Return to factory for maintenance
		Main-board chip is damaged	Return to factory for maintenance
		Poor grounding / no grounding	Check the grounding of the ion bar and plant equipment, and return to the factory for maintenance
6	The product is smoky or burnt	High voltage module is damaged or insulation of the discharge seat is damaged	Return to factory for maintenance

## ▲ Maintenance

- The ion bar should be cleaned and maintained in time according to the use environment and the required electrostatic protection requirements in order to ensure the good performance of the product. That is, gently remove the carbon deposits on the discharge electrode, discharge socket, and metal discharge body with electrostatic brush, dust-free cotton swab, dust-free cloth dipped in anhydrous alcohol, which will improve its performance significantly. Note:
  - Operation must be done 10 minutes after power cut off.
  - It must be cleaned when dust or white products appear on the tip of the needle during use. Use dust-free cloth dipped in anhydrous alcohol to clean when brush can not meet the cleaning requirements.
  - The ion bar must be powered on after alcohol is completely volatilized after cleaning. No other organic solvent can be used to clean the ion bar.
- If the switch working indicator light of the power plug-in port on the panel of the ion bar is off, it should be stopped and repaired by professional maintenance personnel. It can be used only after the electrical performance index is normal.

## ▲ After-sales service

AP-AB1218 air-source electroshock-proof pulse AC ion bar has undergone rigorous testing and aging treatment before ex-work. Its performance has completely reached the relevant indicators marked in the usage instruction.

- AP&T makes a commitment to the customer that any defective parts inspected by AP&T will be repaired or replaced free of charge within one year from the date of purchase. However, this commitment does not apply to:
  - The device is incorrectly used or installed.
  - Damage caused by negligence or accident during use.
  - Modified, disassembled or repaired by other service departments not authorized by Anping Company.
- The alloy electrode is a consumable product which is not included in the scope of warranty and will be charged for replacement when repairing.
- AP&T shall not be liable for any incorrect use of the products except for repair or replacement of parts as specified above.

# AP&T®

AP&T

Professional electrostatic intelligent monitoring/analysis  
and elimination solution provider

## Speciality Creates Value

Shanghai Anping Static Technology Co.,Ltd

Tel : +86-21-64517676

Fax : +86-21-64517673

Postcode : 200233

Website : [www.ap-static.com](http://www.ap-static.com)

Address : 3/F,Building 27,No.69,Guiqing Road,Shanghai,China



AP&T