

AP&T®

Shanghai Anping Static Technology Co.,Ltd

High Efficient Electroshock-proof

AP-AB1205 Ion Bar



— AP&T —



Widely used in printing, UV flatbed industry

Effectively solve the problem caused by static electricity



Static removal

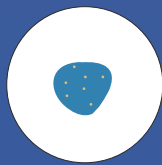

Prevent adhesion of objects



Prevent sticking



Control ink splashing

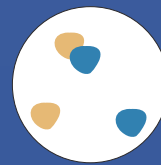

Prevent uneven scattering

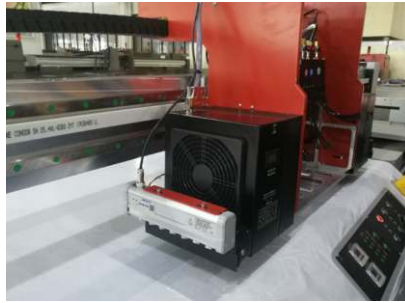

High efficient



Safe

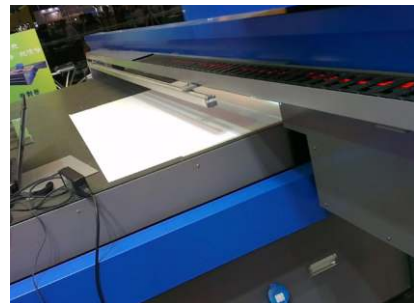

Static removal

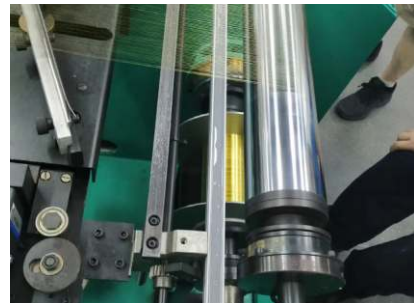

Intelligent Control

Ion balance/ ion output frequency adjustable

The output ratio of positive and negative ions is adjustable, which can be used to adjust the ion balance voltage

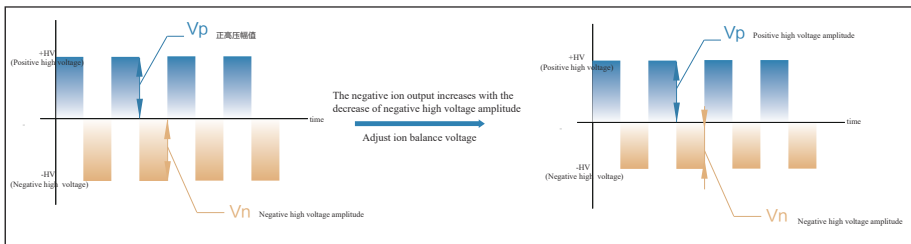
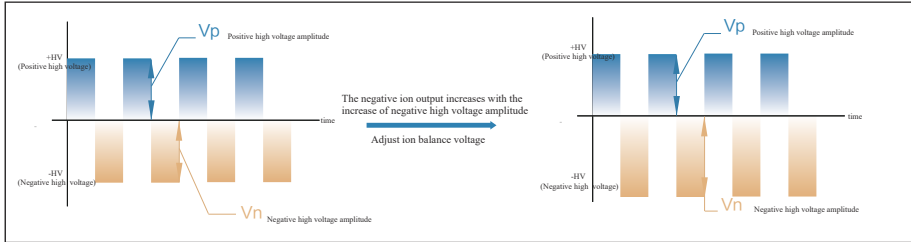

The output frequency of positive and negative ions is adjustable, which can be applied to different discharge distance to achieve faster discharge speed

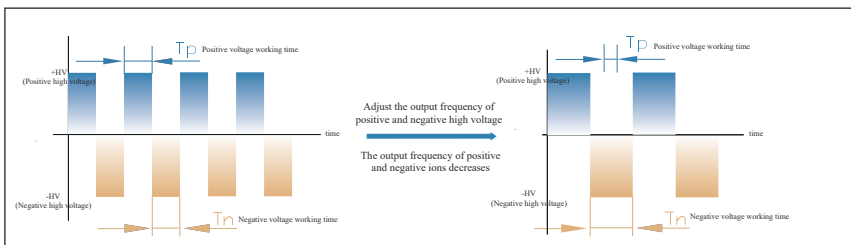
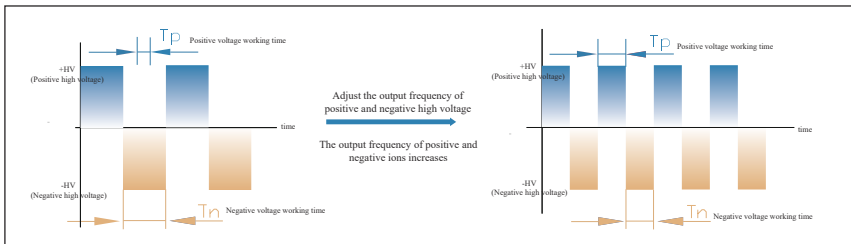



Intelligent Control

Ion balance/
ion output frequency adjustable



Button function instructions

Function	Symbol	Operation instructions
Unlock		Unlock before adjusting operating parameters.
Run / Pause		Device starts running when power is on. Press "STOP" to standby and no high voltage output. Press "RUN" again and the device will start working.
Adjust cleaning cycle	CT _{TH} → +/-	Press CT _{TH} first, then +/- to increase or decrease the cleaning cycle. The default cleaning period is 15 days, and the adjustment range is 1-60 days. The cleaning function will alarm when the countdown is 0 days. Power off and restart to restore the set time. The cleaning function becomes invalid if the value is set to 0 days.
Adjust frequency	FREQ → +/-	Press FREQ first, then press +/- to increase or decrease the frequency of positive and negative ions output.
Adjust ion balance voltage	IB _N → +/-	Press IB _N first, then press + when the positive voltage on flat panel detector or discharge object surface is high, press IB _N first, then press - when the negative voltage on flat panel detector or discharge object surface is high until the ion balance reaches the ideal status.
Confirm	CAL → OK	Press CAL and then OK to confirm after the output parameters are adjusted.

Pulse AC

The effect of static eliminating is better compare to power frequency AC ion bar

Comparison with traditional AC

The pulsed AC method alternately applies "+" and "-" high voltage to one electrode needle to generate two polar ions.

Compared with the AC method, the ion generation efficiency is higher. Electrostatic elimination ability can be fully plated on matter for short or long distance. Beside, frequency adjustable so the working distance is extended. Positive and negative ion output ratio adjustable so easy for intelligent control.

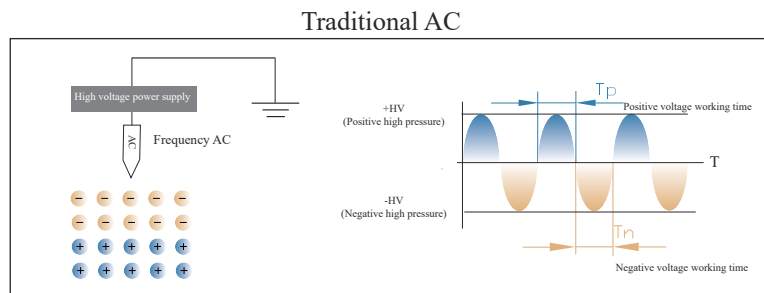
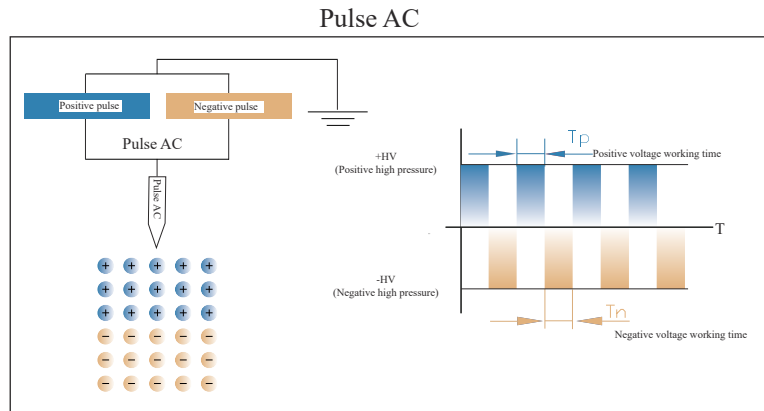

Efficiently static removal

Stay away static trouble & for clean production environment

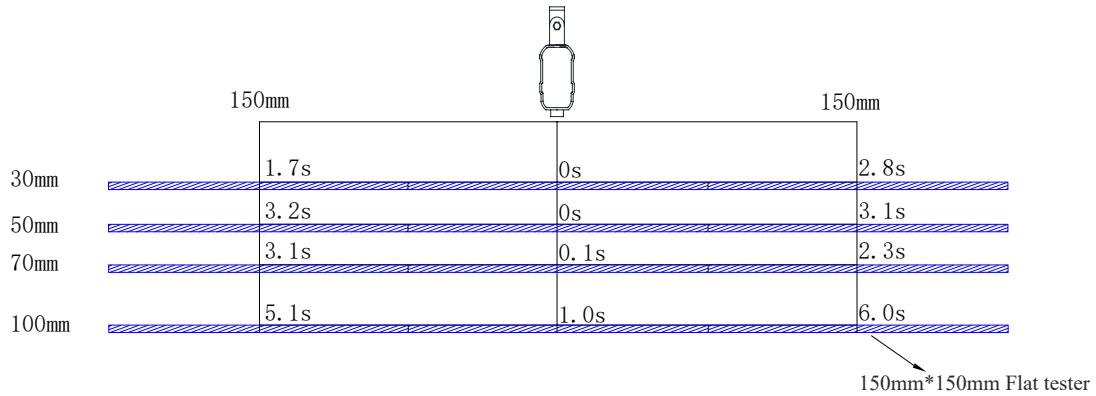

Test Conditions: Ion bar length: 410mm

Working frequency: 30Hz

Test standard: ANSI/ESD.STM3.1, SJ/T 11446—2013

Test instrument: Trek157 static tester

Test voltage: $\pm 1000V \rightarrow \pm 100V$ attenuation

Test environment: humidity $50 \pm 5\%$; temperature $23 \pm 3^\circ C$

The test data diagram is as follows (test distance: 100mm, ion bar length: 410mm, working frequency: 30Hz):

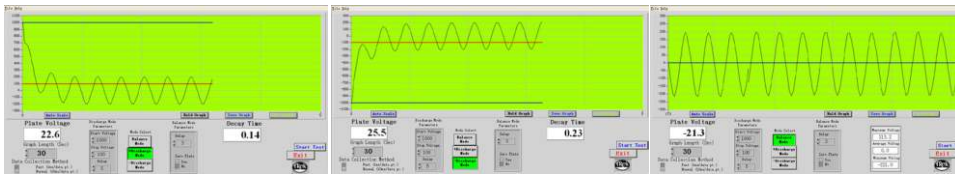

Test data under other conditions are as follows

Test diagram

Ion bar length: 410mm; working frequency: 30Hz;

Test distance (mm)	Discharge speed			Ion Balance voltage
	Vertical	Level	Positive discharge time (S)	
30	-150	1.0	1.7	-13.5
	0	0.0	0.0	-6.3
	150	2.8	2.7	10.1
50	-150	1.4	3.2	-23.3
	0	0.0	0.0	7.5
	150	1.8	3.1	-15.8
70	-150	3.0	3.1	17
	0	0.1	0.1	13.7
	150	2.1	2.3	19.9
100	-150	5.1	4.2	2.75
	0	0.5	1.0	9.9
	150	6.0	5.4	21.3

Features

Safe / Easy to use / Durable



No.1

Easy installation

M5 sheet slider nut installation accessories provided. Put the slider nut into the slot of the ion bar. Slide left and right to adjust position and can adapt to various installation environments.

No.2

Electroshock-proof

Protection against electroshock.



No.3

DC24V high flexible towline power cord

The standard length of the power cord is 1500mm and the low-voltage wiring of 24V can eliminate the aging phenomenon of the cable caused by the discharge and the impact on the peripheral equipment, which can build a highly reliable system.

No.4

Working status visualization

Red light alarm when high voltage abnormal.

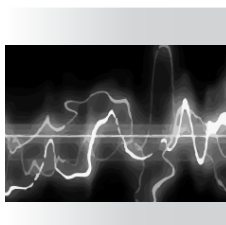

No.5

CE certification

It can effectively prevent the external electromagnetic interference from affecting the normal operation of the ion bar. This is a static electricity eliminator with high safety and high reliability.

Specification

Details / Parameter / Size

Product Details

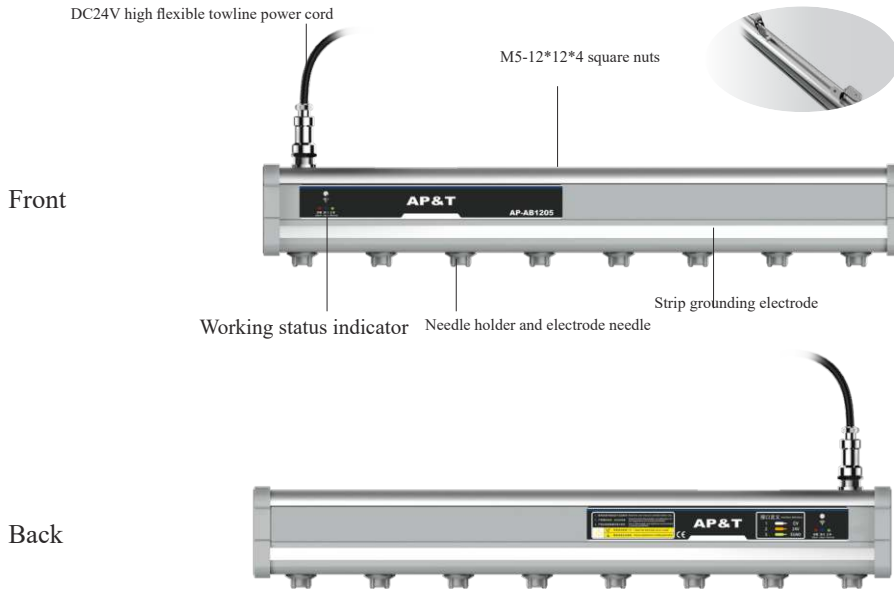

Product Size

unit: mm

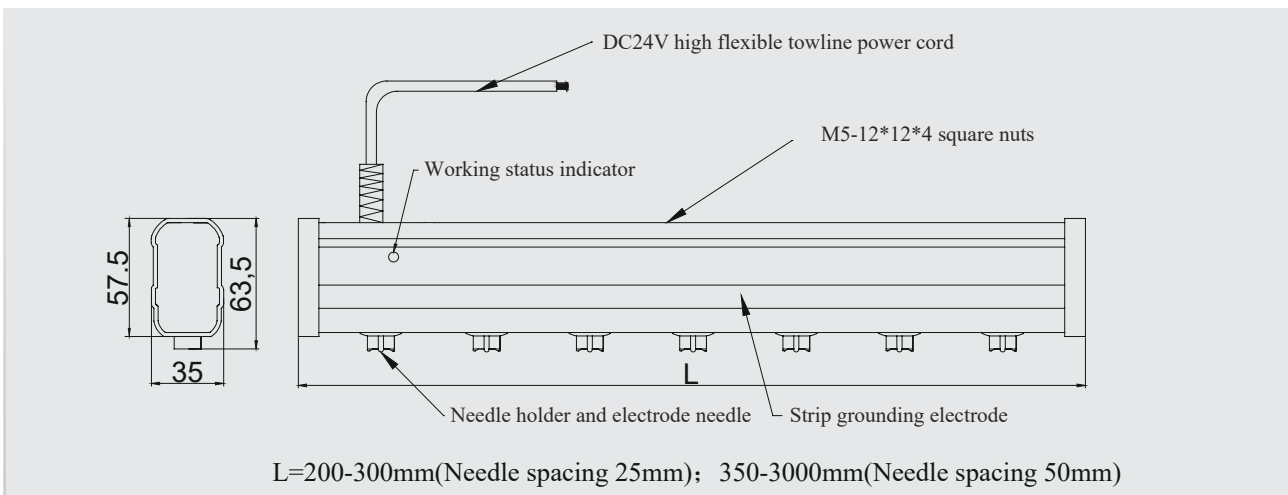

Product Parameter

Model	AP-AB1205
Input voltage	DC 24V
Power	10W
Electrode pin voltage	V _{pp} :8-12KV
Ion emission	Pulse AC
Emitter electrode	SUS
Discharge structure	Resistance coupling
Output frequency	1,3,5,10,20,30,50Hz; (EX-Work setting: 30Hz)
Discharge range	L*W*H: Bar Length*200*100mm
Installation distance	30→100mm
Ion balance	≤ ±30V (AVE)
Discharge speed	≤1S (Test distance 100mm)
Status indicator	Green light - normal, Blue light - standby, Blue light flashing—debugging /cleaning, Red light - Abnormal high voltage
Working temperature	0°C-50°C
Working humidity	< 70%
Dimensions(L*W*H)	{200-300mm(Needle spacing 25mm); 350-3000mm(Needle spacing 50mm)}*35mm*63.5mm
Bar material	Flame retardant PVC, AL, SUS
Packaging accessories	M5-12*12*4 square nut
Warranty	1 year
Certification	CE

Use of the product

Installation step / Installation position / Packaging accessories

Installation step

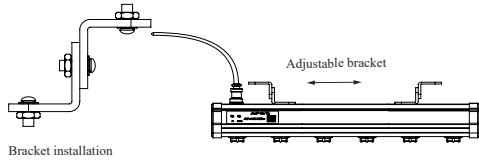

1

1. Take out the ion bar, adapter power supply, power supply network cable, stainless steel mounting brackets and other accessories from the packing box.
2. Install the stainless steel mounting brackets on the base mounting slot on the ion bar.

Connection method 1

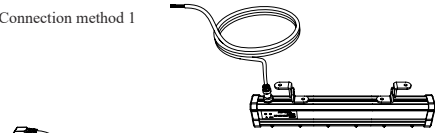

Connection method 2



2

- Connection method 1: Connect one end of the DC24V high-flexible power supply cable to the industrial control power supply and insert one end of the aviation plug into the aviation socket on the ion bar.
- Connection method 2: Connect one end of the network cable into the DC24V adapter power supply and the other end into the aviation socket on the ion bar.

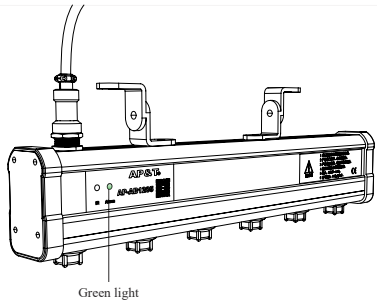

3

The panel indicator lights green to show that the ion bar is working.



4

Use the remote control to adjust the voltage output parameters under the appropriate air pressure. When the positive voltage on the surface of the flat panel detector or the object to be discharged is large, press to adjust "IB-"; when the negative voltage on the flat panel detector or the surface of the object to be discharged is large, press "IB+" to adjust until the balance is adjusted to the ideal status.

DC24V high flexible towline power cord wiring diagram

接口定义 Interface definition		DC24V high flexible towline power cord wiring diagram	
Power cord color	Connecting info	Power cord color	Connecting info
1	0V	White	0V
2	24V	Orange	+ 24V
3	EGND	Green	EGND

Installation position

1. Choose the best static elimination position and install the bar body and the matching power adapter firmly after the static detection of the on-site working environment. The installation angle should be perpendicular to the surface of the charged body and the installation distance can be referred to the following table. (Ex-work setting is 30Hz. Use the remote control to adjust if you need to adjust the output frequency. Configure a flat panel tester if you want to see the adjustment results)

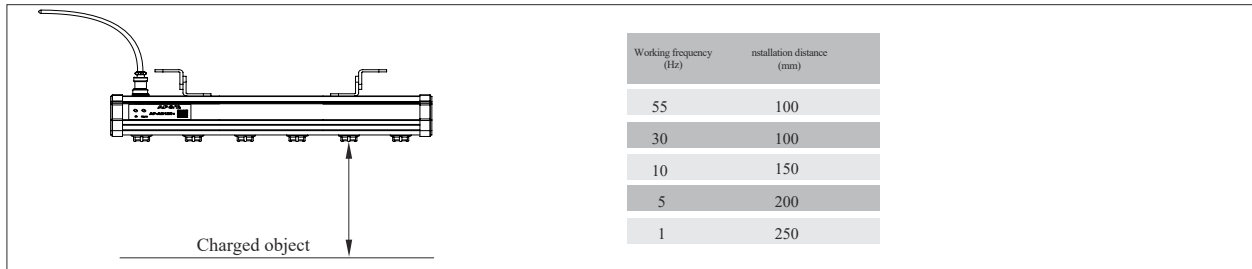

2. The ion bar grounding electrode is not allowed to be covered by other objects.
3. It is advisable to install two ion bars side by side with an interval of more than 100mm. Two ion bars should be staggered by more than 100mm if they are to be installed face to face.

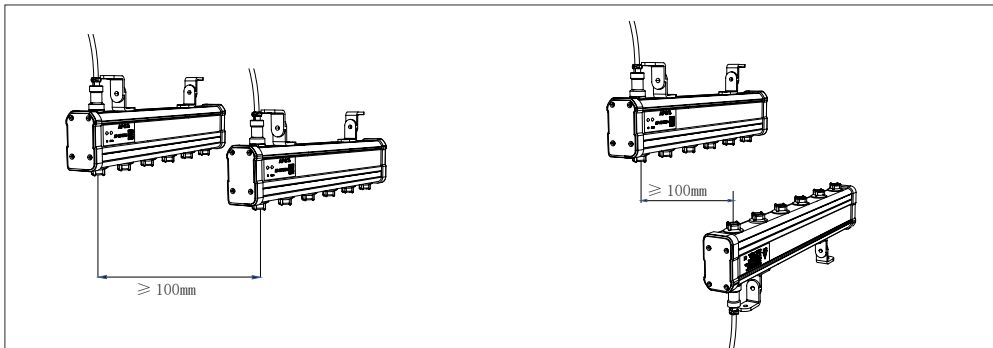



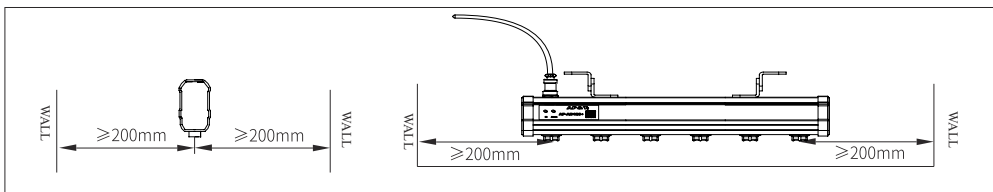



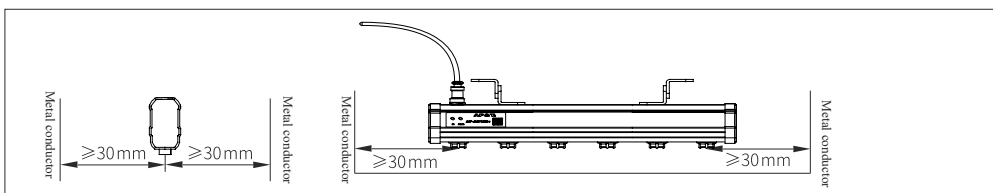





4. It is advisable to be more than 200mm away from obstacles such as walls.



5. For the safe use of the ion bar, the ion bar discharge electrode should be at least 30mm away from the metal conductor and metal grounding body and the bar body must be reliably connected to the grounding wire.



Packaging accessories

Name	Image	Part No.	Specification	Quantity
Power Adapter		OSP000601	GRT-240200: DC24V 2A, dual network port output, Size: 123*61*40.5mm (L*W*H)	1
National standard power cord		8YXG25110	Standard:1.8m, optional:3m/5m	1
Three-core flexible power cord with aviation plug (optional)		—	Standard 1.5m (customizable on site)	1
Network cable (optional)		—	Standard:2.5m, 5m/10m:optional	1
L-shaped stainless steel mounting bracket		AP8038005	Height 25mm/Width 16mm/ Thickness 3mm Aperture 5mm (measured 4.8mm)	4
Square nut		AP8933000	M5*12*12*4	2
304 stainless steel spring washer		AP8943000	M5	6
304 stainless steel flat gasket		AP8946004	M5	6
304 stainless steel pan head Phillips screw		AP8900001	M5*12	6
Hex nuts		1LML05000	M5	4
Needle holder		AP6604000	—	—
Remote control		AP2253011	Infrared remote control, neutral panel (L*W*H: 85.76*39.76*6.66)	1

Safety warning

1. Please read the instruction manual carefully before installing and using this equipment.
2. The whole set of equipment must be reliably grounded during use, otherwise it is easy to cause abnormality or even damage to the ion bar.
3. Do not use this equipment in environment where humidity is > 70%.
4. It is strictly forbidden to use this equipment in flammable and explosive environments.
5. Unauthorized disassembly of the product is strictly prohibited, internal maintenance and repair must be performed by professionals.
6. The product is strictly prohibited to touch liquid during use, otherwise an abnormality may occur and cause electric shock or fire.
7. Power must be turned off during inspecting or replacing the product, otherwise it may cause electric shock or fire.
8. The product is specially designed to eliminate static electricity. It is strictly forbidden to use it for other purposes. Any abnormal use may cause machine failure, electric shock, fire and other accidents.
9. Its strictly forbidden to touch the electrode needles when power is on, otherwise it is easy to cause malfunctions and electric shock accidents.
10. The electrode needle is a sharp metal object, please use it with care.
11. Please check the specifications of the power supply before powering on the product. Any power supply that does not meet the specifications will cause damage to the product.
12. Please check the product power cord/communication cord regularly and replace it immediately if it is damaged. Otherwise it is easy to cause problems such as electric leakage, poor communication, and abnormal operation.

⚠ Troubleshooting

NO.	Faults	Reasons	Solutions
1	The indicator on the panel is off	Poor contact of the power cable	Check whether the power cable is in good condition and securely connected
		Power supply mismatch	Confirm the power supply specification (INPUT: 100—240VAC 50/60Hz; OUTPUT: 24VDC 2000mA)
2	The electrostatic removal performance decreased obviously	Discharge needle is polluted and damaged	Clean or replace the discharge needle
		Whether the discharge seat is tightened	Confirm the discharge seat is tightened
		Ion bar positioning is incorrect	Confirm the best installation location
3	The electrostatic removal performance decreased	There are conductors or other ion bar around	Remove (moving) conductors or other ion bar
4	Panel indicator red light on	Electromagnetic interference	Turn off the power switch / unplug the power cable, restart the ion bar
		Abnormal discharge	Confirm the installation location and stay away from surrounding conductors
		No power supply for high voltage module	Return to factory for maintenance
		High voltage module is damaged	
5	Unable to discharge	High voltage module is damaged	Check the grounding of the ion bar and plant equipment, and return to the factory for maintenance
		Main-board chip is damaged	
		Main-board chip is damaged caused by poor grounding or no grounding	
6	The product is smoky or burnt	High voltage module is damaged or insulation of the discharge seat is damaged	Return to factory for maintenance

⚠ Maintenance

- The ion bar should be cleaned and maintained in time according to the use environment and the required electrostatic protection requirements in order to ensure the good performance of the product. That is, gently remove the carbon deposits on the discharge electrode, discharge socket, and metal discharge body with electrostatic brush, dust-free cotton swab, dust-free cloth dipped in anhydrous alcohol, which will improve its performance significantly. Note:
 - Operation must be done 10 minutes after power cut off.
 - It must be cleaned when dust or white products appear on the tip of the needle during use. Use dust-free cloth dipped in anhydrous alcohol to clean when brush can not meet the cleaning requirements.
 - The ion bar must be powered on after alcohol is completely volatilized after cleaning. No other organic solvent can be used to clean the ion bar.
- If the switch working indicator light of the power plug-in port on the panel of the ion bar is off, it should be stopped and repaired by professional maintenance personnel. It can be used only after the electrical performance index is normal.

⚠ After-sales service

AP-AB1205 has undergone rigorous testing and aging treatment before ex-work. Its performance has completely reached the relevant indicators marked in the usage instruction.

- AP&T makes a commitment to the customer that any defective parts inspected by AP&T will be repaired or replaced free of charge within one year from the date of purchase. However, this commitment does not apply to:
 - The device is incorrectly used or installed.
 - Damage caused by negligence or accident during use.
 - Modified, disassembled or repaired by other service departments not authorized by Anping Company.
- The alloy electrode is a consumable product which is not included in the scope of warranty and will be charged for replacement when repairing.
- AP&T shall not be liable for any incorrect use of the products except for repair or replacement of parts as specified above.

AP&T[®]

Speciality Creates Value

Shanghai Anping Static Technology Co.,Ltd

Tel : 021-64517676

Fax : 021-64517673

Postcode : 200233

Website : www.ap-static.com

Address : 3/F, Building 27, No.69, Guiqing Road, Shanghai, China

